

# LESSONS FROM JAPAN: A LOOK AT CENTURY HOUSING SYSTEM

Robert Schmidt III, Toru Eguchi and Simon Austin

Loughborough University, Department of Civil and Building Engineering

*Keywords: century housing system, construction, system engineering, adaptability*

## 1 INTRODUCTION

Japanese traditional wooden houses are a good example of system architecture (Fukao, 1987). Originating from Chinese temple construction, the housing is based on the distance between column centres known as a *ken*. Both the widths and depths of all spaces were multiples of this standard unit and formed the frame of reference for the remaining components – timber structure, tatami mats, doors, and even furniture (Hirai, 1998). Modern housing (particularly post-WWII, during a national shortage) moved away from this type of construction in an effort towards mass production. In the mid-70s, when the number of houses surpassed the number of households, a shift occurred from focusing on quantity to quality, and the emphasis returned to a more systemic approach in the context of the industrialized era inspired by a systems approach to schools in the UK (CLASP) and the US (SCSD). Several projects arose led by KEP (Koden Experimental Housing Projects), but it wasn't until 1980, and the start of The Century Housing System (CHS) that a national campaign took place in an attempt to coordinate all of the previous efforts into a single system (Utida, 1983).

CHS started as a government-led research initiative formed primarily by academic members from 1980-1982. The objective was to extend the longevity of housing by developing a systems approach to the housing sector focused on the changeability of components throughout the building life, reducing premature functional obsolescence by increasing the building's adaptability. As shown below, the approach utilized interface matrices, essentially DSMs, to identify the types of relationships between components stressing their capacity to be changed without damaging other parts (i.e. the interfaces between components). This paper looks at the system, process, and key findings from their experience to understand their applicability to DSM, system design, buildings, and designing for adaptability in today's context.

## 2 THE SYSTEM

Century housing system set out to develop long-lasting, durable and a higher quality of housing. The system took into account the sequence of construction, spread of design responsibilities, and allowance for maintenance through component compatibility (Utida 2002). The following subsections highlight some of the relevant aspects of the system.

### 2.1 Component Groups

The level of abstraction considered for the component groups is important. Too small a consideration, such as bolts, would not be able to take advantage of the changeability at the level of the building, while too large of a unit would create a uniform product (Utida 1983). The driver was to produce meaningful customization without unnecessary differentiation just for the sake of it. *Component groups* consisted of the components themselves, the connections outside of the group, and all the embodied work needed to design, produce, construct and maintain the group's functionality. The first task undertaken was to determine guidance for division of the building into component groups. The result was ten principles:

1. Divide concepts into standard shapes
2. Divide to be functional
3. Divide corresponding to set of usability (e.g. movability)
4. Divide according to the durability level

5. Divide corresponding to types of constructor (division of labour)
6. Divide coordinating with construction process (sequence)
7. Divide corresponding to the organizations of production and logistics
8. Divide to avoid not reducing the flexibility of combination
9. Divide to understand each price of parts or components
10. Divide coordinating with types of living (ownership model)

The system places the component groups into 5 categories according to their durability (lifespan) and their economic rationality (see Table 1). The decisions were based on accumulated experience in the construction industry. The categories moved from *Infill*, individual consumption assets, to *Support*, public, fixed assets. The overall concept is driven by the capacity for the long lifespan components not to be damaged with the changing of the shorter lifespan components demonstrating careful thought for future maintenance and management of the building. Which category the components fell into was not mandated by the committee, but only suggested as a possibility. It was then up to the designer to classify the components based on their given solution (i.e. each project would have a somewhat unique breakdown of where the components ‘fit’ based on the specifics of the proposed design and the designer’s interpretation).

Table 1 CHS Layers (Adapted from Utida, 2002)

CHS 5 layer breakdown		
Component Examples	Life span category	average
light bulbs, packing	3-6	4
hot water heater, home appliances, piping, wiring	6-12	8
movable partitions, built-in furniture	12-25	15
exterior door and windows, roof	25-50	30
foundation, main columns and beams	50-100	60

## 2.2 Rules

The rules took into consideration that, unlike an off-the-shelf consumer product, each building site is unique and needs to be adjusted to. Thus, the rules could not be absolute, but allow interpretation by the designer to accommodate the specific context of the project (as opposed to standards). The rules themselves were not only about *how to make things* (jointing at interfaces, dimensional reference systems, tolerances, etc.), but also *how to set up production organizations* (e.g. sequence of work, arrangement of materials, and dimensions). For example, different types of components (structural framed, flat panel-like, box-shaped or vertical panel) will have different relationships to the grid lines in order to optimize their coordination (e.g. center-to-center face to face etc.). Thus, it is important to understand the characteristics of the components and how they are to be assembled. How the different components relate to the grid lines and how they interface between themselves is then contingent on their sequence in construction. Most rules worked at varying scales augmenting the ability for enough diversification to take place based on component sizes (e.g. dimensions in the horizontal direction were based on a 900mm, 300mm, and 150mm series). Over time, it is important to allow the rules to evolve to changing circumstances as well (Utida 1983).

## 2.3 The interface map

The interface map was used to visualize types of relationships between the components and whether they followed the principles of CHS or not. It was thus used as a *representational device* aimed at highlighting the problematic relationships between components (broken rules) rather than be used as an *analytical/ developmental tool* for system optimization. The matrices were updated after each design iteration to show how the relationships had/ hadn’t improved (again serving as a visual tool). Figure 1 is an example of a reinforced concrete apartment building where in most cases there was limited examination between same level components (e.g. 8, 30, 60, etc.). This bias was due to the thought that those components, in theory, would be changed at the same time, whereas the

relationships between different lifespan components were seen as more crucial. The primary exception to that logic was the emphasis they put on the service related components where many of the conflicting relationships (broken rules) occur. It was felt the accessibility and changeability of service elements to be the most critical part of a building from their experience and lead to the focus on those components.

Figure 1 Reinforced concrete apartment example (Adapted from CHPC 1986)

Vertical box	Horizontal box	60	30	15	8	4																				
		Structural frame	Plumbing of common area	Opening (e.g. entrance)	Building envelope wall (interior side)	Floor framing (free floor)	Ceiling framing	Partition (fixed)	Partition (movable)	Frame for fittings	Piping (for hot water)	Piping (for gas and drain)	Piping (for feeding water)	Wiring	Sanitary fixture	Heating	Exhaust pipe	Kitchen	Lavatory sink	Bathroom unit	Kitchen heating	Fan	Information box of the house	Floor finishing	Wall finishing	Ceiling finishing
60	Structural frame																									
	Plumbing of common area																									
30	Opening (e.g. entrance)	<																								
	Building envelope wall (interior side)	^	○																							
	Floor framing (free floor)		<																							
	Ceiling framing	<	<																							
	Partition (fixed)	<	○	<	<	A																				
	Partition (movable)	<	<	<	○	○																				
	Frame for fittings	○	<	<	<	<	<																			
	Piping (for hot water)	<			X																					
	Piping (for gas and drain)	<	^		X	X																				
	Piping (for feeding water)	<			X	X																				
	Wiring			A	X	A	X																			
	Sanitary fixture	<						<			^	^	^													
15	Heating	<									^															
	Exhaust pipe	<			X																					
	Kitchen	○									^	^	^		^											
	Lavatory sink										^	^	^		^											
8	Bathroom unit	<									X	X	X		^		A									
	Kitchen heating										^						○									
	Fan																^	<								
	Information box of the house																									
4	Floor finishing	^	^	^															^							
	Wall finishing		^	^					^	^									^				^	^		
	Ceiling finishing									^													^	^		

○ When we exchange the parts in the vertical boxes (top), we will not damage the horizontal boxes ones (left)  
 X Opposite of (○); Needs improvement  
 A Some durability, horizontal boxes will win at joint  
 ^ Unify the parts by using screw and glue for example. Hard to separate because of joining method  
 < Unify the parts by using screw for example. Hard to separate because of the location and joining method

## 2.4 Qualification

After the initial two year academic research initiative, the government broadened the research to include a large industry consortium for an additional five year business committee. At the end of this, the promotion committee produced a five volume guidebook (CHPC, 1985) which served as a reference for industry and the public with rules, ranges, definitions, and conditions to apply for the housing incentive. The Center for Better Living and their committee were in charge of the qualification process. In between the design and construction phases the developer would apply for approval which the Better Living Organization would oversee. The problem with its implementation was the amount of work/ time it took to prepare the application compared to the economic incentive received for obtaining approval. The direct incentive was received by the end user where as a building that qualified as a CHS, JHFA could provide a preferential loan programme, adding more than 1 million yen loan/ per unit. Thus, the incentive for the company applying was indirect and only based on the potential to sell the units quicker. In this situation, the incentive was relatively weak, due to the nature of the Japanese philosophy that the public sector shouldn't provide a financial incentive to private development unless it benefits common/ public areas of the development.

## 2.5 Post occupancy evaluations

A paper published by Wakiyama et al. (2000) looked at how residents and managers recognized the system and how it worked for them. The study was conducted sixteen years after the initial occupancy in which approximately 70% of the 160 units responded were original users. Figure 2 shows the survey results from the original residents of the two buildings and the desire/capacity for them to change the listed attribute. The top two changes were an increase in electrical capacity and wall paper. The movable partitions proved problematic for many users with regards to: not being able to move themselves; having a limitation of where they could be moved (fixed module); and a lack of spare walls and/ or storage space for unused ones. In contrast, the change of layout was minimum as most residents got to reflect their requirements as part of the process in the design.

Figure 2 Survey results from original residents (Adapted from Wakiyama et al 2000)

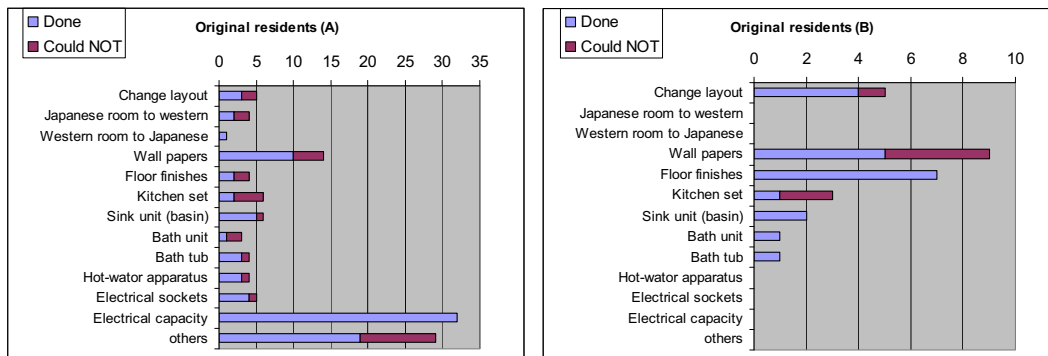

In another study residents were asked why they chose that particular apartment building (as opposed to a conventional solution). They were given a list of twenty characteristics to choose from and allowed to select whichever ones influenced their decision in purchasing the residence. The top three characteristics were *size* (87%), *green surrounding environment* (82%), and *sunlight/ good indoor air flow* (73%). It is notable that '*easy to change layout*' (23%) was eleventh out of twenty characteristics (Bansho et. al. 2002).

## 2.6 Dissemination & reflections

In the end the system proved too complicated to be implemented by industry and disseminated rather poorly. As of the year 2004, the Centre for Better Living website listed only 40 projects that had been completed over a 16 year period (22 apartment buildings, 18 detached houses). It appears that the attempt to provide *maximum flexibility* to the rules added complications due to the lack of clarity/ simplification towards what to do (i.e. sometimes things are easier if you have less freedom to interpret them). In addition, many felt five levels of separation to be too many and added to the confusion (Matsumura 2009). One of the main findings was that CHS focused primarily on the individual spaces, and not the common spaces which affected all the units. Subsequent development focused on how the common spaces could be developed better and be used to accommodate more of the changes (as access is easier and less disruptive). At that time, the social perception for such a type of dwelling was unclear; the ability to change the dwelling was not a high priority in the consumer's mindset. Even today, the reuse of housing (change of owner) in Japan represents only 15% of the market (Minami, 2010).

Regarding the continual effort in Japan, the most critical relationship - between services and the building - remained the leading cause of premature functional obsolescence as service technologies and their associated demands continue to shift at a fast pace (Matsumura, 2009). The practical reaction which followed CHS by the government was to simplify the system to two levels (unchangeable 'support'/changeable 'infill'). The SI (support/infill) system has been successfully disseminating into industry and become recognizable by almost all in the Japanese industry. The simplification has shown there are certain elements which are subject to major change and others which can neglect it. The final leitmotif of the project was, '*we should be careful about details*'.

### 3 LESSONS

In this section we relate our understanding of CHS and the use of their interface map to a) DSM analysis generally and b) system design, and specifically for investigating c) buildings and d) adaptability.

#### 3.1 DSM analysis

- Dependencies were only depicted one-way considering only the residual effect of the component(s) that were not changed (no consideration went into the damage of the removed component) – thus, an empty half of a matrix.
- Rather than simply showing the relationships (binary matrix), different conditions were indicated to show the ease of changeability between the two components (types of relationships)
- CHS considered the integration of physical components to multiple domains such as *process* (manufacture, installation, etc.) and functionality to provide a holistic look at the group's changeability, but didn't capture any of those relationships in the interface matrix (single domain map).
- *Experience* dictated the focus (i.e. where to look for problems) rather than allowing the matrix or an algorithm to provide 'hidden' dependencies to inform the 'story'.
- Several lost opportunities by only using the matrix as a visual device (changing the type of mark in the box) as opposed to a design tool (e.g. clustering, sequencing) to inform possible changes.

#### 3.2 System design

- Different types and scales of components may require different integration rules.
- The ten principles of division are helpful when thinking about different ways to decompose a system.
- Rules need to evolve with changing circumstances over time (not static standards).
- There is a need for continual feedback from both the installation and use stages back to the design phase (again allowing for learning to occur).

#### 3.3 Buildings

- When thinking about how to decompose buildings, it is helpful to consider not only the physical durability but also the social durability or desire of a component to be changed.
- The reality that every building exists within a different physical context (a degree of uniqueness) demands a set of rules which provide flexibility to allow for successful application/mutation.
- The long life expectancy of buildings and change of ownership, management and/or user creates long-term information and facilities management problems (e.g. the ability to follow-through and coordinate the intended changes).
- The large scale of buildings compared to other products is important as well. Many times the scale of the cost and time to change is not justifiable and becomes too much of a burden on the user.
- The array of stakeholders in the construction industry requires a multi-perspective approach and consideration for successful dissemination.

#### 3.4 Adaptability

- It is important to use a level of abstraction (scale) which takes advantage of standardization while offering maximum diversity.
- When considering adaptability it is important to break systems down regarding their desired changeability (i.e. intended lifespan).
- Adaptability is not a primary motivator in people's decision making process, and to what extent/where it is applicable becomes a crucial consideration (not simply about a capacity).
- Successful adaptability is a balance and integration of human (social) adaptability and building (physical) adaptability.
- When thinking about the lifespan of components it is helpful to provide 'windows of change' as opposed to specific times.

## 4 CONCLUSIONS

In conclusion, CHS exhibits many positive features, some of which we look to improve upon, including the use of DSM as an active design tool. One of the strongest realizations of a project which had tremendous financial and government backing is the limitation to which technical feasibility can drive wide spread dissemination when social conditions are not ready for such applications. As well as, in an industry, such as the construction industry, which relies on the active participation of numerous stakeholders simplicity and clarity are key to driving compliance falling short of making it compulsory. All of the above, play a large part in understanding to what degree *flexibility of process* and *adaptability of product* can be supported and realized.

## REFERENCES

- Bansho, M., and H. Takai. 2002. Detailed characteristics of infill remodelling: A study on remodelling of dwelling units designed by century housing system. *Summaries of Technical Papers of Annual Meeting Architectural Institute of Japan* 1: 207.
- Century Housing Promotion Committee (CHPC). 1988. *Century housing system Pamphlet*. Japan: Center for Better Living.
- Century Housing Promotion Committee (CHPC). 1986. *Century Housing System Business Committee: Annual Activities 1985*. Japan: Center for Better Living.
- Century Housing Promotion Committee (CHPC). 1985. *Century Housing System Guidebooks; Volumes I-V*. Japan: Center for Better Living.
- Fukao, S. 2008. The history of developments toward open buildings in Japan. Paper presented at Education for an Open Architecture, Ball State University.
- Fukao, S. 1987. Century housing system: Background and status report. *Open House International* 12 (2): 30.
- Hirai, K. 1998. *The Japanese House Then and Now*. Tokyo: Ichigaya Publishing Co., Ltd.
- Matsumura, Shuichi. Personal Interview, 13 July 2009.
- Minami, K. 2010. The new Japanese housing policy and research and development to promote the longer life of housing. Paper presented at the 16<sup>th</sup> International Open and Sustainable Buildings Conference, Bilbao, Spain. 17-19 May 2010.
- Utida, Yositka. 2002. *The Construction and Culture of Architecture Today: A View from Japan*. Tokyo: Ichigaya Publishing Co., Ltd.
- Utida, Yositka. 1983. Century housing system – A systems approach to component coordination. *Micro IF* 3211, (4): 41.
- Wakiyama, Y., M. Tsunoda, and S. Matsumura. 2000. A research on the effectiveness of the century housing system at the early-built CHS houses. *AIJ Journal of Technology and Design* 10 (June).

Contact: Robert Schmidt III  
Loughborough University  
Department of Civil and Building Engineering  
Loughborough  
Leicestershire, LE11 3BQ  
United Kingdom  
+44 (0) 1509 228527  
r.schmidt-iii@lboro.ac.uk  
www.adaptablefutures.com



# layers and strategies

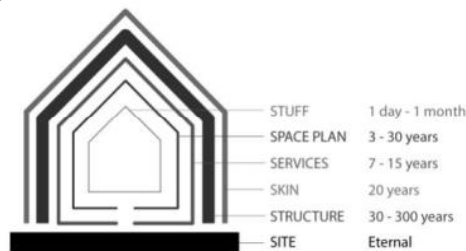

(Adapted from Brand's *How Buildings Learn*)

able	type of change	stakeholder	scale	Time (cycle)	Brand's layers					
					Stuff	Space	Services	Skin	Structure	Site
adjustable	task, user	user	components	daily/ monthly	○					
versatile (flexible)	space	user	components	daily/ monthly	○	○				
refitable	component, performance	user/ owner	components	7 years		○	○	○		
convertible	function	user/ owner	building	15 years		○	○	○		
scalable	size	owner	building	15 years		○	○	○	○	
movable	location	owner	building	30 years					○	○

Brand 1994	SI 1960	Slaughter 2001	Rush 1986	Duffy 1990	CHS 1982	KEP 1974	Leupen, 2005	Kendall, 2005	Bogner, 1940	BWM, 2009
Site									Groundwork	Green Zone
Structure	Support	Structure	Structure	Shell	60 years	Exterior Walls (shelter)	Structure	Primary System	Shell Assembly	Blue Zone
Skin		Exterior enclosure	Envelope		30 years		Skin			Green Zone
Services	Infill	Services	Mechanical	Services	15 years	ventilation/ air conditioning	Services	Secondary System	Installations	Blue Zone
Space plan				Scenery	8 years	sanitary facilities	Access			Red Zone
Stuff			Interior Finish Systems	Interior	Set	4 years	interior system		Tertiary System	Accessories and interchangeable parts

12th International DSM Conference 2010- 3

# ten principles of division

- Divide concepts into standard shapes
- Divide to be functional
- Divide corresponding to set of usability (e.g. movability)
- Divide according to the durability level
- Divide corresponding to division of labour (roles)
- Divide coordinating with construction process (sequence)
- Divide corresponding to the organizations of production and logistics
- Divide to keep the flexibility between groups of components
- Divide to understand each price of parts or components
- Divide coordinating with types of living (ownership model)





# system layers

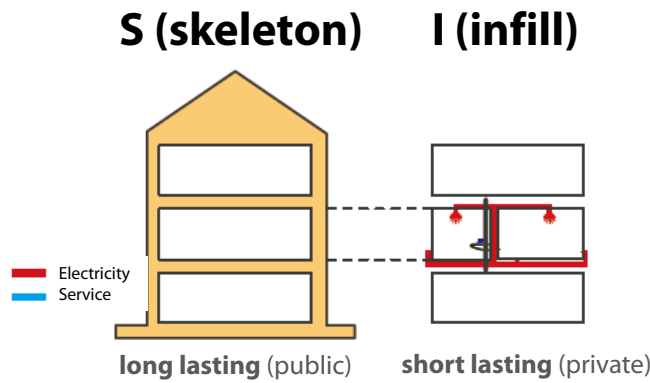

CHS 5 layer breakdown		
Component Examples	Life span category	average
light bulbs, packing	3-6	4
hot water heater, home appliances, piping, wiring	6-12	8
movable partitions, built-in furniture	12-25	15
exterior door and windows, roof	25-50	30
foundation, main columns and beams	50-100	60



# example table

CHS Building Decomposition (example)		
Building Component/ System	Description/ Example	Possible Layer
Foundation	RC	60
	Conventional, 2"x4"	30, 60
Structural frame	RC	60
	Conventional, 2"x4"	30, 60
Roof	Double roof	30, 60
	Water proofing	15
	Gutter	15, 30, 60
Non-structural building envelope wall and panel	Joint and padding	08
	RC	30, 60
Opening (e.g. entrance)	Conventional, 2"x4"	15, 30
	Bathhub	08
Bathroom unit	Wall, floor and ceiling in RC	08, 30
	Wall, floor and ceiling in Conventional, 2"x4"	15, 30
	Others	08, 30
		30
Floor framing (free floor)		08, 30
Building envelope wall (interior side)		30
Ceiling		30
Partition		30
Joinery (finishing carpentry)		No benchmark
Doors and windows		30
Storage		08, 15, 30
Doors for storage		08, 15, 30
Stairway		Same as Structural frame
Floor finishing		04, 08, 15
Kitchen	Kitchen cabinet	15
	Heating	08
Lavatory sink		15
Ventilation system	Duct	30
	Range hood	08
	Fan	08
	Heat source	08
Air conditioning	Deliver	30
	Equipment	15
	Individual ownership space	30
Piping	Common space	30, 60
	Wiring	60
Sanitary	Body	30
	Parts	04, 08

	example A	example B	example C	example D
	Apartment house	Apartment house	Wooden detached house	Wooden detached house
	60	60	60	60
	60	60	60	60
			30	30
			15	15
			30	30
		30	15 (raised)	30
	08		08	15 (raised)
	08, 30		30	15
	30	30	30	30
	30 (fin. 08)	30	30	30
	30 (fin. 08)	30	30 (mov. 15)	30
	30	30	30	30
				15
				60
	08	04	08	08
	15	15	15	15
	08	08	08	
	15	15		15
	30	15 (reduced)		
	08	08	15 (raised)	
	08	08	08	
	08	08	15 (raised)	
	30	30		
	30 (raised)	15, 30 (raised)	15	15
	30	30	30	30
	60	30 (reduced)	30 (reduced)	60
		30	30	30

# reinforced concrete apartment

Vertical box	Horizontal box	60	30	15	8	4
Structural frame	Structural frame					
Plumbing of common area	Plumbing of common area					
Opening (e.g. entrance)	Opening (e.g. entrance)					
Building envelope wall (interior side)	Building envelope wall (interior side)					
Floor framing (free floor)	Floor framing (free floor)					
Ceiling framing	Ceiling framing					
Partition (fixed)	Partition (fixed)					
Partition (movable)	Partition (movable)					
Frame for fittings	Frame for fittings					
Piping (for hot water)	Piping (for hot water)					
Piping (for gas and drain)	Piping (for gas and drain)					
Piping (for feeding water)	Piping (for feeding water)					
Wiring	Wiring					
Sanitary fixture	Sanitary fixture					
Heating	Heating					
Exhaust pipe	Exhaust pipe					
Kitchen	Kitchen					
Lavatory sink	Lavatory sink					
Bathroom unit	Bathroom unit					
Kitchen heating	Kitchen heating					
Fan	Fan					
Information box of the house	Information box of the house					
Floor finishing	Floor finishing					
Wall finishing	Wall finishing					
Ceiling finishing	Ceiling finishing					

- When we exchange the parts in the vertical boxes (top), we will not damage the horizontal boxes ones (left)
- A Same durability; horizontal boxes will win at joint
- X Opposite of (○); Needs Improvement
- < Unify the parts by using screw for example. Hard to separate because of the location and joining method
- ^ Unify the parts by using screw and glue for example. Hard to separate because of joining method

12th International DSM Conference 2010- 7

# detached wooden house

Vertical box	Horizontal box	60	30	15	8	4
Foundation	Foundation					
Structural frame	Structural frame					
Floor concrete of entrance	Floor concrete of entrance					
Stairway	Stairway					
Wiring	Wiring					
Roof backing	Roof backing					
Roof finishing	Roof finishing					
Eaves ceiling	Eaves ceiling					
Gable, fascia board	Gable, fascia board					
Façade backing	Façade backing					
Façade finishing	Façade finishing					
Attached parts to façade	Attached parts to façade					
Doors of entrance	Doors of entrance					
Partition system	Partition system					
Floor, finishing and backing	Floor, finishing and backing					
Wall, finishing and backing	Wall, finishing and backing					
Ceiling, finishing and backing	Ceiling, finishing and backing					
Frame of openings	Frame of openings					
Interior doors and windows	Interior doors and windows					
Storage	Storage					
Piping	Piping					
Toilet equipments	Toilet equipments					
Ventilation	Ventilation					
Wall??	Wall??					
Bathroom equipments	Bathroom equipments					
Bathroom, finishing and baking	Bathroom, finishing and baking					
Sink	Sink					
Kitchen	Kitchen					
Drawers	Drawers					
Heating and cooling equipments	Heating and cooling equipments					
Floor finishing	Floor finishing					
Wall finishing	Wall finishing					
Ceiling finishing	Ceiling finishing					

- When we exchange the parts in the vertical boxes (top), we do not damage the horizontal boxes ones (left).
- @ When we exchange the parts in the vertical boxes, we will damage the ones in the horizontal boxes. However, both parts will be exchanged at the same time due to durability.

12th International DSM Conference 2010- 8

supplemental drawings

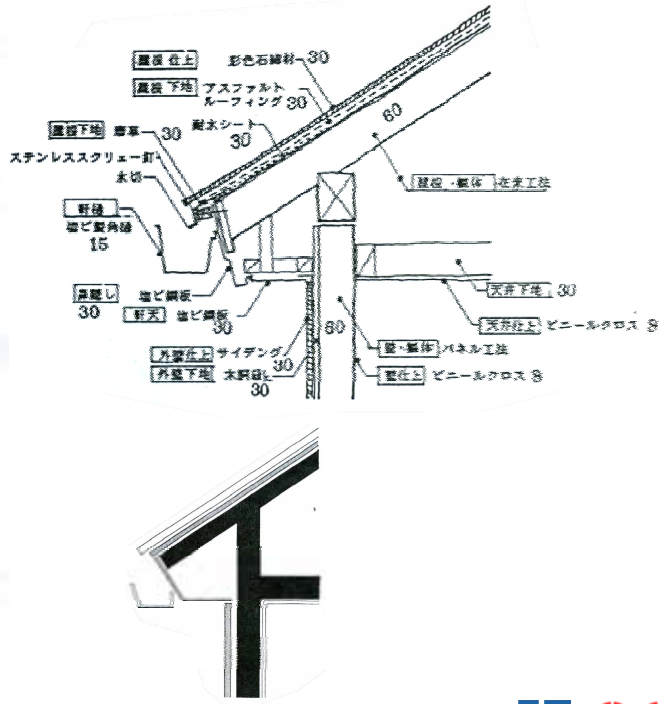
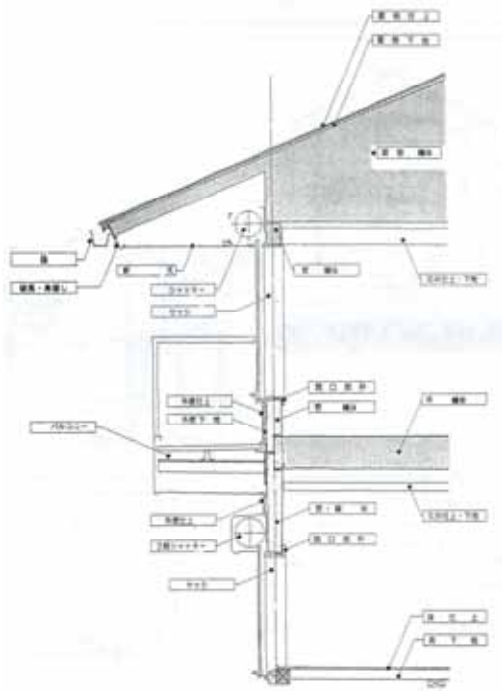

system evaluation

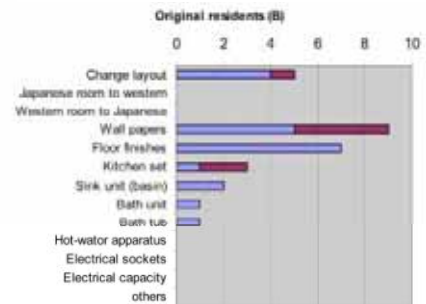
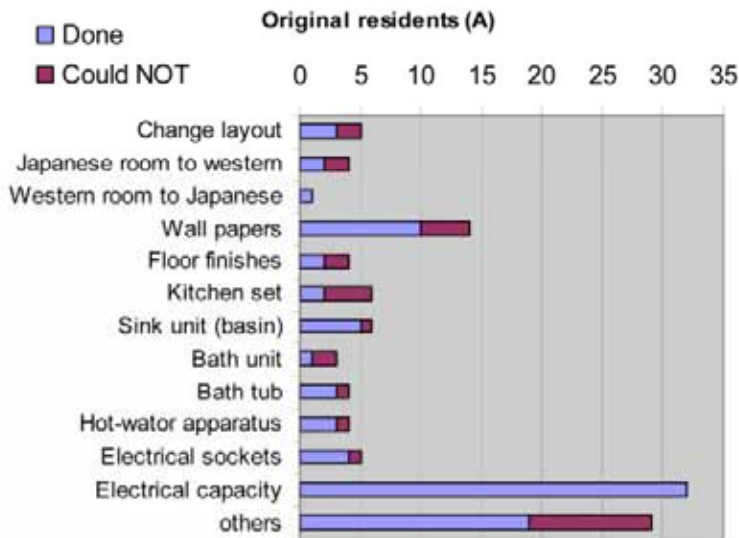

## CHS reflections

- System proved too complicated to be implemented by industry and disseminated rather poorly (40 projects over a 16 year period)
- Five levels of separation was considered too many
- Changing some of the desired parts remained difficult for the user (capacity, availability/ storage)
- Change of services remained the most critical relationships
- In the future utilize common spaces more for change of components (opposed to the individual spaces)
- Social perception needs greater awareness (create a greater demand)
- We should be careful about details



## DSM lessons learnt

- Dependencies were only depicted one-way considering only the residual effect of the component(s) that were not changed (no consideration of the removed component).
- Rather than simply showing the relationships, different conditions were indicated to show the ease of changeability (types of relationships)
- Considered the integration of physical components to multiple domains such as *process* and *functionality*, but didn't capture any of those relationships in the interface matrix (single domain map).
- *Experience* dictated the focus (i.e. where to look for problems) rather than allowing the matrix or an algorithm to inform the 'story'.
- Several lost opportunities by only using the matrix as a visual device as opposed to a design tool (e.g. clustering, sequencing) to inform possible changes.

time-based design

a looseness of...

