

# PRODUCT FAMILY DEPLOYMENT STRATEGIES UNDER DIFFERENT TYPES OF PRODUCT VARIETY DESIGN CIRCUMSTANCES

Kikuo Fujita, Ryota Akai and Hirofumi Amaya  
Osaka University, Japan

## ABSTRACT

As product variety design has become recognized as an effective framework typically for meeting the demands toward mass customization, product platform and family design has been intensively studied in the last two decades. While their focuses have been put mainly on consumer products, their possibilities must be spread over various kinds of products, which are under different time frames. This paper prospects the possibilities of design methodologies for expanding product variety design to such wider meaning. For the purpose, how product family deployment under given product platforms are affected by types of product variety design circumstances and what strategies should be used for respective types are discussed. Firstly, the relationships among platform design, product family development and market mechanisms are reviewed for revealing their constraints. Secondly, product design circumstances are categorized into four types under the matrix by the scale of investment and the scale of production, and product variety design circumstances are investigated respectively under the categorized types. Thirdly, some practical cases of product family deployment are analyzed for validating such investigation. Finally, research agendas for developing optimal design methodologies are consequently argued toward the wider meaning of product variety design.

*Keywords: Product Family, Product Platform, Design Strategy, Product Variety Design, Optimal Design Framework*

## 1 INTRODUCTION

The economy of scale had been pushed the mode of manufacturing to what we called mass production of consumer products in the early 20th century. Such paradigm shift had not only dramatically changed the mechanism of manufacturing but also coevolutionally made the society to be much civilized and transformed life styles into individual ones. Those trends had led the maturation of society and life. After 1970s or later, the mode of manufacturing has been further moved to a more sophisticated one that is symbolically called mass customization. Under the paradigm of mass customization, a variety of consumer products are offered to the market with sharing hidden modules or component across different products for effectively and efficiently meeting with the diversity of customers' needs. Since the benefit of such a paradigm is realized through another level of the economy of scale, the advantage could be somehow beneficial for all kinds of products and any appropriate design methodologies for its achievement should be utilized in various industrial practices.

Upon receiving the trend of mass customization in practice, the research field of product variety design and/or product platform and family design has attracted much attentions for scientifically enhancing the practices since around 1995 (e.g., [1]). The distinctive characteristics of this field are as follows: the design problem deals with not a unique product but a series of products. It becomes more complicated or complex. The decisions that are conceptually taken place in the early phases of the design process are essentially important, because strategic decisions dominate the details of the whole. On the other hand, the research activities are spread over analysis of successful cases for revealing the modes of complexity, definition of convenient indexes for measuring the design optimality even under conceptual information, development of computational approaches for rationally generating design alternatives under complicated tradeoffs, etc. Among them, computational approaches, i.e., optimal design methods based on mathematical programming must be promising for resolving and overcoming

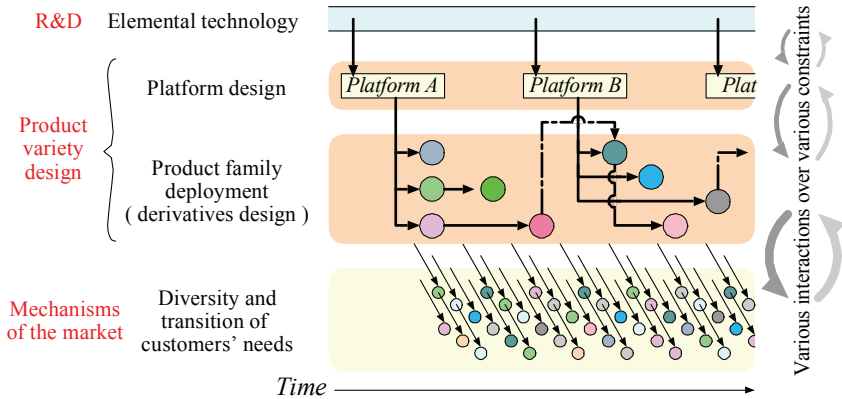

Figure 1. Product platform design and product family deployment [4]

such complexity of product variety design as well as or more than ordinary complicated design problems [1-3]. However, their developments are limited within the circumstance in which a series of products, i.e., a product family, is simultaneously designed and produced. In other words, they do not consider the time frames about how and when respective products are launched to the market under an established platform, how and when different platforms are concurrent or changed over, and so forth. Such limitations must become a significant barrier when expanding the product variety design methodologies over all kinds of products.

This paper discusses the strategic design frameworks for product family deployment under given product platforms with considering the *time frames* on product implementation as the prerequisites for developing optimal design methodologies. In this paper, firstly, the relationships among product platform design and product family deployment and associated constraints are investigated. Secondly, since they must be affected by the individual modes of product family deployment, product design circumstances are categorized into four types under the matrix by the scale of investment and the scale of production. And then, product variety design circumstances are investigated under the categorized types respectively. Fourthly, some practical cases of product family deployment are analyzed for demonstrating and validating such investigation. Finally, research agendas for developing optimal design methodologies for wider meaning of product variety design with consideration of time frames are extracted based on the general investigation and a series of case studies.

## 2 PRODUCT PLATFORM DESIGN AND PRODUCT FAMILY DEPLOYMENT

### 2.1 Structure of product variety design process

When expanding the viewpoint on design from a single product to a series of products, any concept that categorizes the contents of products into their common aspect and individual aspects must be introduced. Under the viewpoint of product planning [4], the former is 'platform,' which corresponds to the fundamental architecture, underlying elemental technologies, their predefined implementation manner, etc. as the templates for developing individual products. The latter is 'derivatives,' which correspond to individual products that are respectively developed under the platform as shown in Figure 1. As the development of elemental technologies becomes to require much more investment and the requirements of products becomes much wider, this kind of scenario of product design and development become more essential. In the product variety design, a platform plays a role of basis for a product family development, derivatives correspond to members of a product family, and their development and launch to the market are intended to meet with diversity and transition of customers' needs.

## 2.2 Planning of product family deployment and underlying constraints

When viewing the product variety design as shown in Figure 1, the overall design process is decomposed into platform design and product family deployment as its major components. As the general nature of design process, the final design results are committed in the early phases and a major part of effort and cost is incurred in the latter phases [5]. Concurrent engineering tell us the importance of the early phases such as planning and conceptual design under such a sense. It is derived that product platform design must be important for excellence of product variety design rather than product family deployment and that product family deployment could be performed in something like a routine-like manner in comparison with product platform design. However, as shown in Figure 1, the interaction with product family deployment and market mechanisms must be another important factor in product variety design, especially when considering wider time frames of product variety design. That is, how the issues of the latter phases are considered in the early phase becomes critical for the excellence in product family deployment, in a similar way with the integration of design and production under concurrent engineering.

The interactions among product platform design, product family deployment and market mechanisms over wider time frames under the above meaning are itemized as the following issues and constraints:

- ♦ **Presence of each product in the market** --- When each product should be designed and launched to the market must be decided along with time frames apart from the design of product platform. As a result, since some product may not be done so, what products are realized from the possible ones is determined under the relationship with various factors.
- ♦ **Restriction on product launch under internal resource limitation** --- Design and development of each product require some engineering works and resources. Since the total amount of them that can be utilized is restrictive, how many products can be designed and launched in each time frame is constrained. This means that there is a possibility that even though a product is demanded in the market, it cannot be launched at the same time frame.
- ♦ **Restriction on product launch under external competition** --- There are usually competitors in the market. This means that different companies may offer simultaneously similar products and that even if a company cannot offer a certain product, another company may be able to offer an equivalent or similar product. In the former case, such products will be competed in the market for example under the measure of cost performance. In the latter case, once a company obtain a certain share and establish the corresponding production infrastructure and/or brand image, it must be difficult for other companies to get into the market. Their result directly affects the volume of sales that must be equal to the number of production units.
- ♦ **Dependency among development of individual products** --- Even within the activities of a certain company, the possibilities of some products, which are the results of product platform design, can partially share underlying engineering processes, system modules, etc. In such cases, which product is introduced antecedent to other products, which product is introduced subsequent to other products, and so forth must be strategically decided beyond the first issue. Their result affects efficiency of design and development under the above internal and external restrictions.

These issues over time frames can be summarized as the problem for determining the timing and sequence of module design and consequently determining the time frame when each product is launched to the market as shown in Figure 2. The strategic planning of product family deployment dominates their determination, even though some promises are consequent on the result of product platform design. That is, strategic planning of product family deployment must be a significantly important phase of product variety design and development.

Beyond the above issues, the market trend is fugacious along with time frames in most cases. This means that those issues further face various types of *uncertainties*. In other words, *flexibility* of product family deployment must be managed somehow against such uncertainties. While a certain part of such flexibility is affected by the result of product platform design, some part of it could be managed through strategic planning of product family deployment. That is, a product platform provides product architecture, which consists of system structure, list of module slots, etc., potentially implementable modules for respective slots. Under the combinatorial nature of such modules into products, the following situations must happen in the phases of product family deployment, which is shown in Figure 2: It may be enough to introduce a certain subset of potentially implementable

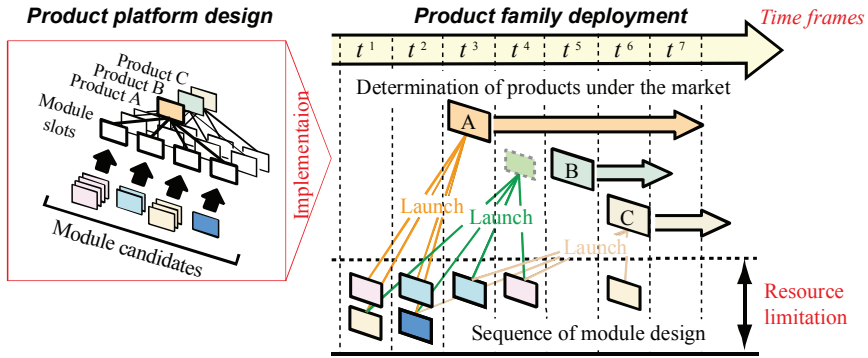

Figure 2. Product family deployment over time frames

modules for realizing a series of products as a product family. When some modules are almost compatible each other, they can be diverted for a specific product, if some associated drawbacks are negligible. The decisions related to those freedoms must be included in the possibility of product family deployment.

### 2.3 Related studies and their trends

Since the research themes of product platform and family design are spread gradually to more sophisticated ones beyond early outcomes [1], some issues related to ones over the time frames or ones faced market completion have been discussed in the last five years.

For example, Hui and Azarm introduced a demand model based on conjoint analysis to product family design [6]. This was the initial research that brought the marketing factors into product family design. Wassenaar and Chen proposed an approach to consider the preferences of customers on product attributes such as brand, warranty, performance, etc. in demand modeling under discrete choice analysis [7]. Michalek *et al.* further considered the communication among marketing, design and production by the means of analytical target cascading [8]. Shiau and Michalek expanded the consideration to the existence of competitors in the market under these trends [9]. Jaio *et al.* introduced the real options framework to product family design for dealing with various uncertainties [10]. Gonzalez-Zugasti *et al.* also discussed an options-based approach for product platform selection [11]. Fujita and Akai discussed an integrated optimal design throughout commonalization, customization and lineup arrangement by focusing the flexibility of shared modules across a range of products [12].

As shown in the above studies, the product platform and family design problems in which some issues mentioned in the previous subsection are included somehow have been challenged by introducing various models and approaches that are effective in dealing with market mechanisms and associated uncertainties. However, while each study provided an approach for some aspect of the overall problems, the big picture of product family and platform design problems under the general circumstances shown in Figure 1 is not revealed comprehensively behind them. Such a picture must be effective and desirable for revealing the significant research challenges and structuring various models and approaches against the individual circumstances of product family and platform design problems over time frames.

### 2.4 Role and form of optimal design methodologies

Toward this direction, the applications of optimal design paradigm is promising as well as the above studies, because they can formally deal with complicated problems and investigate onto tradeoffs. In the paradigm modeling of naive design problems as mathematical forms are significant and rather could be bottle necks, while optimization algorithms and computer performance are important. Such a tendency must be much more significant in the application to product variety design and its complicated problems. Under such a viewpoint, Fujita *et al.* categorized the optimal design

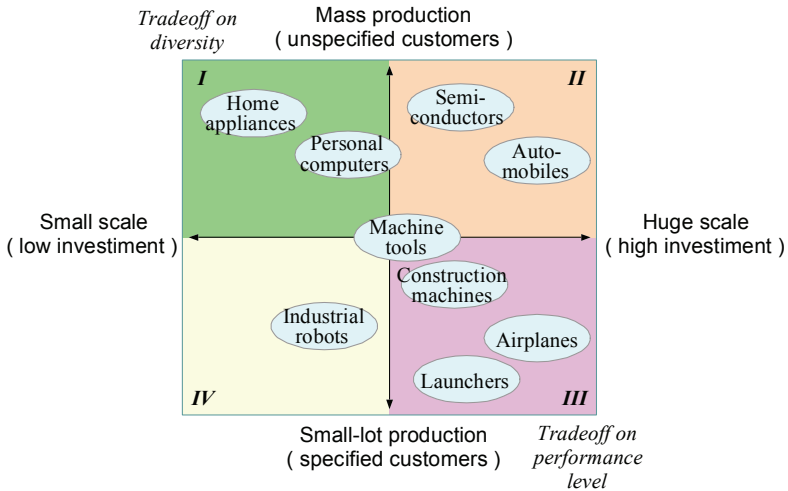

Figure 3. Diversity of products and their categorization into four types [13]

problems of product variety under modular architecture into three classes and proposed optimization-based design approaches to respective ones with case studies [2, 3]. In their studies, classification of problems plays a key role for developing respective optimal design methodologies in the way that optimization algorithms are customized within operational limitations according to the classified contents of respective classes and that extracted contents under the classification enables respective customization of design optimization methods beyond underlying complicatedness.

### 3 TYPES OF PRODUCT FAMILY DEPLOYMENT STRATEGIES

#### 3.1 Product characterization matrix and categorization of diverse problems

While the target circumstance of product variety design focused in this paper is generally described as shown in Figures 1 and 2, its whole shape must be too complicated to uniformly discuss its details. Even though it can be described, any rational design approaches or methodologies must not be applicable due to its complicatedness and operational limitations.

Ohtomi, who is a corporate researcher at a general electric company that manufactures home appliances, semiconductors to power plants, pointed out the followings [13]: the first point is that circumstance of design problems is diverse in various ways. The second point is that various design approaches and methodologies must be strategically utilized by selecting ones appropriate to individual problems under the standpoint of industrial practices. Regarding the applicability of design approaches and methodologies, he categorized the kinds of products over a matrix defined with two axes, the scale of investment and the scale of production, as shown in Figure 3. That is, when a problem is in small scale, the amount of investment is forced to be low. When a problem is in large scale, the amount of investment is forced to be huge. When a target product is under mass production, customers are not individually specified and needs-oriented design becomes essential. When a target product is under small-lot production, customers are explicitly specified and design and development become technology-driven. Regarding the applicability of design approaches and methodologies, therefore, for example, computer-aided engineering (CAE) techniques must be applied to the products categorized into the right-down cell, because they are technology-driven and longer design lead-time can be accepted. Design-for-X (DFX) methodologies is the most essential for the products categorized in the left-up cell, because they must meet with vague and transitory customers' needs and design cycle time is fairly short. Those mapping between the natures of different products and the variety of design approaches and methodologies is expected to be beneficial when exploring and revealing the general but concrete landscapes of product family deployment.

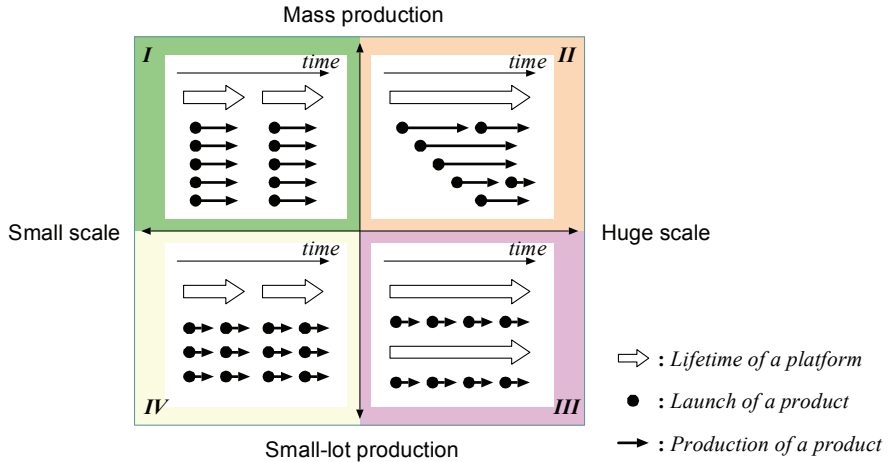

Figure 4. Representative circumstances of product family deployment strategy

In the following subsections of this section, individual circumstances of product family deployment are investigated in general. For the convenience of the discussion, four cells on the matrix are named as follows as shown in Figure 3.

**Type I** --- Ones of small-scale and mass-production products.

**Type II** --- Ones of huge-scale and mass-production products.

**Type III** --- Ones of huge-scale and small-lot-production products.

**Type IV** --- Ones of small-scale and small-lot-production products.

Besides, Figure 4 shows representative circumstances of product family deployment, which will be mentioned on respective types in the following subsections. Further, the next section provides practical case studies corresponding to them respectively.

### 3.2 Product family deployment strategy for Type I

The circumstance of Type I is small-scale and mass-production. One of home appliances is typical of this, and one of personal computers has a tendency of this circumstance, as shown in Figure 3. It indicates that a platform can be relatively easily replaced as compared with other circumstances, that each product can be designed with less work and resource expense, and that a variety of customers' needs must be much diverse. Therefore, it is expected that once a platform is introduced, a series of product are instantly designed and launched to the market. It is also expected that such an operation is iterated in relatively short cycle. The deployment strategy of such a situation is illustrated in the left-up cell of Figure 4. Since product platform design and product family design are almost simultaneously executed, the consideration of time frames in product family deployment could be eliminated for this type.

### 3.3 Product family deployment strategy for Type II

The circumstance of Type II is huge-scale and mass-production. One of automobiles is typical of this, as shown in Figure 3, as many companies and alliances introduce the platform strategy in practice. It indicates that each product is technology-driven but that different products must be introduced to meet with the variety of customers' needs. The former demands much engineering work with much resource expense, but the latter does not permit its iteration over a series of products. In order to overcome such a conflict, the following scenario is expected to be effective: the fundamental technologies that can be unfolded to a series of products are established as a platform, and then various variants, i.e., members of a product family are explored under the common platform. Since design of each product requires relatively much engineering work and resources, some common parts across individual members are made to be spread over a time frame for resolving the limitation of resources.

The deployment strategy of such a situation is illustrated in the right-up cell of Figure 4. Since the issues discussed in Subsection 2.2 are most likely in this type, the strategic planning of product family deployment may be most significant among four types.

### **3.4 Product family deployment strategy for Type III**

The circumstance of Type III is huge-scale and small-lot production. Aeronautical and aerospace products are typical of this, as shown in Figure 3. It is considered that each product is genuinely technology-driven and that customers' needs are drawn by the potential level that corresponds to elemental technologies. Further, it is expected that the amount of engineering work and resources expensed and associated risks may exceed ones that are permitted in the scheme of design and development of a single product. Therefore, a platform is shared among development of a series of products for distributing expenses and risks over them, and design and development of respective products are executed sequentially one by one. That is, design and development of a platform and ones of each product are simultaneously executed. On the other hand, it is difficult to meet with the diverse customers' needs under such a way of product design and development. Thus, ones for different needs must be parallelized. The deployment strategy of such a situation is illustrated in the right-down cell of Figure 4.

### **3.5 Product family deployment strategy for Type IV**

The circumstance of Type IV is small-scale and small-lot production. Ones that can be categorized into this may be few, but industrial robots can be categorized into in this type, as shown in Figure 3. As mentioned in Subsection 3.1, it may be unlikely in general, because product variety design is demanded under either mass production, which corresponds to mass customization under the variety of customers' need, or huge scale, which leads high investment and much expense. However, it could be a type of product family deployment under the formality. In order to bring the benefits of product family deployment, the strategies for the other types may be somehow hybridized for this type. Such a situation is illustrated in the left-down cell of Figure 4. That is, once a platform is introduced, a set of products are designed and launched to the market and they are changed or replaced under the platform. However, after a certain period the platform must be replaced for introducing new elemental technologies to new products.

## **4 CASE ANALYSES**

In this section, several practical cases are reviewed and analyzed for validating the discussion of the previous section.

### **4.1 Ordinary appliances**

Various appliances such as electric ones are usually small scale and mass production and they are categorized into Type I, in which a series of products are simultaneously launched to the market under the unique platform. While many studies on product family design utilized the cases of power tools, coffee makers, electric motors, etc., they are included in this category. Since their details can be found in several literature (e.g., [1]), the case analysis on this type are omitted in this paper.

### **4.2 Toyota's small cars within the Vitz family**

As aforementioned, the platform strategy has become the key to success in the automobile industry. Many companies and alliances utilize it for reducing development cost and enhancing the flexibility against the variety of costumers' needs. The platform for car production means the part of under body which includes chassis, drive train, suspension, etc. For example, Toyota is producing a series of small cars under the Vitz platform, the bland name of which is Yaris in abroad, since 1999. Nissan and Renault share what is called Alliance B Platform for small-size cars. The platform for the previous Gold of Volkswagen was utilized not only for Bora, Golf Wagon, Golf Cabriole and New Beetle but also for Audi's A3 and TT, SEAT, Skoda, etc.

Figure 5 illustrates the product family deployment of Toyota's Vitz family, which is illustrated based on the information on the web page [14]. The styling of automobiles are today categorized into sedan, wagon, mini-van, 2box, SUV, etc., as the purpose and situation of utilization have become so diverse. On the other hand, the development cost becomes much higher than ever due to demands on high performance, environmental consciousness, etc. Thus, Toyota had introduced the Vitz platform



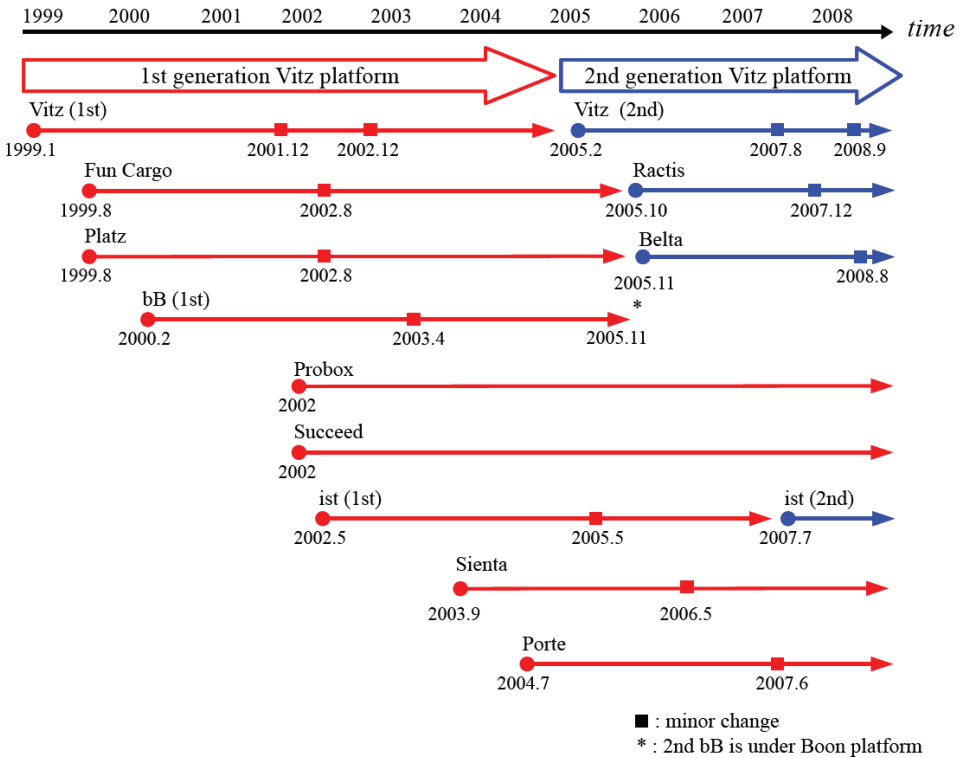

Figure 5. Product families deployed under Vitz platforms [14]

for producing a variety of models in the small car segment. As shown in the figure, first Vitz, 2box type, was introduced at the beginning of 1999, then Fun Cargo, tall 2BOX type, and Platz, sedan type, were introduced in the next year, and further then bB, tall 2BOX type appealing to the young, was introduced in the next year. In 2002, Probox, wagon type, Succeed, wagon type, and ist, SUV type were added to the family, while minor changes were applied to the others around the year. Further, in 2005, the platform itself received minor change, and consequently and gradually Vitz was replaced to its 2nd one, Fun Cargo was replaced to Ractis, and Platz was replaced to Belta while the others were still under the 1st generation platform.

These situation of Toyota's Vitz family well corresponds to the right-up cell of Figure 4, which is the circumstance of Type II.

### 4.3 Japan's development of launchers

Japan's aerospace development is promoted by Japan Aerospace Exploration Agency (JAXA) since 2003, after Institute of Space and Aeronautical Science (ISAS), National Aerospace Laboratory (NAL), and National Space Development Agency (NASDA) were consolidated into one agency [15]. Since the development of launchers is their national mission, JAXA and its predecessors had been concerned in the history of launchers. Figure 6 shows the product family deployment of Japan's launchers, which is illustrated based on the information on the web page [15]. Since launchers are classified into several types under major specification such as payload and throw altitude, they have been developed under the two types; solid-fuel rocket type for smaller payload and liquid-fuel rocket type for larger payload. As show in the figure, launchers of each type have been developed by replacing models one by one under the unique platform and few variants were occasionally introduced simultaneously to meet with different payload. These situation of Japan's launcher family well corresponds to the right-down cell of Figure 4, which is the circumstance of Type III.



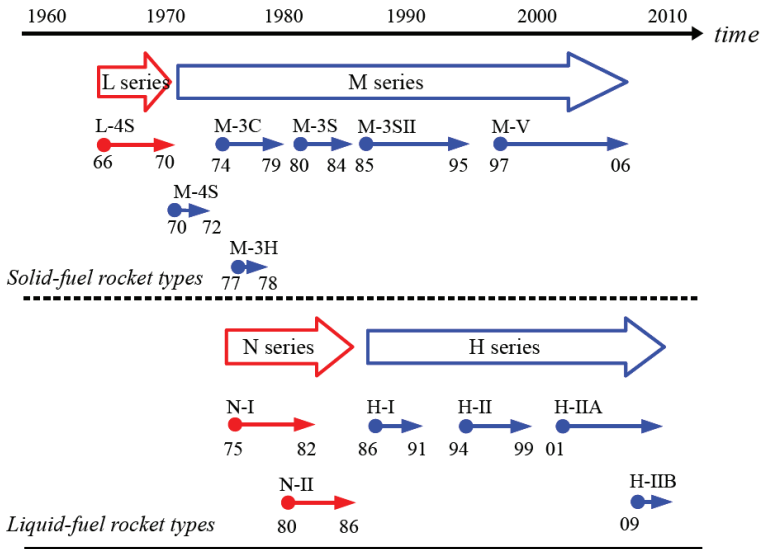

Figure 6. Product family deployment of Japan's launchers [16]

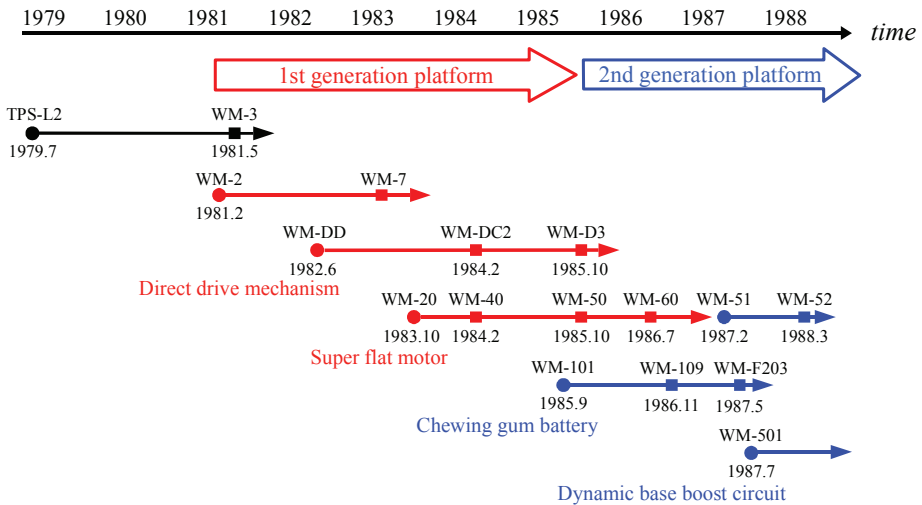

Figure 7. Product family deployment of Sony's Walkman [17, 18]

#### 4.4 The history of SONY's Walkman

The Walkman was the product that was symbolic on SONY's success [16]. The initial model had been introduced as a portable music player with audio cassette tape to the market in 1979. The history was closed in 1999 due to prosperity of other music medium such as CD (Compact Disk), MD (MiniDisk). In its 20-years history, a unique model had been enough under its original functionality in 1979 to the beginning of 1980's. But, as the market of portable music players was grown, a series of models are explored for attracting various voices of customers. During the history after the shift to customization-based competition, various additional features were equipped gradually one by one.

Figure 7 illustrates the history of platform and variants of Sony's Walkman, which is illustrated based on the information of literatures [17, 18]. In the first phase from 1979 to 1981, a unique product was put into the market as mentioned in the above. In 1981, the platform design had explicitly taken, and then a series of products were developed and launched by equipping direct drive mechanism and super flat motor one by one. In 1985, when chewing gum battery, which was an elemental technology, was introduced, the platform for new products was replaced with the second generation. Subsequently, the preceding products were shifted from one under the first platform to one under the second platform in 1987, and a new product was introduced with dynamic base boost circuit in 1987. Meanwhile, some minor changes took place along with the history explained in the above. These interactions between elemental technologies, platform design and product family development are something different from ones of Toyota's Vitz family and Japan's launchers.

When reviewing the practice of SONY's Walkman shown in Figure 7 in comparison with the representative circumstances shown in Figure 4, it is difficult to find direct mapping to either of four types, but it may include the characteristics of Types of I, II and IV somehow. This means the following: regarding product platform and family design problems with consideration of time frames, the illustration of which was given in Figure 2, its fundamental factors can be grasped by the categorization of product family deployment circumstances into four types, which was shown in Figure 3, and definition of representative strategic frameworks for product family deployment, the essences of which were illustrated in Figure 4.

## **5 RESEARCH AGENDAS TOWARD OPTIMAL DESIGN METHODOLOGIES**

### **5.1 Strategic decision making and computational tradeoff analysis**

As product family deployment over several time frames is more complicated or rather complex than its conventional situation within a single time frame, the general discussion in Section 3 and case analyses in Section 4 indicate that various factors are associated with it. On the other hand, they reveal that some representative and essential modes are involved in product family deployment over time frames, and that strategic planning is indispensable for excellence in product variety design. While the framework of optimal design is promising for such difficult problems as mentioned in Subsection 2.4, optimization is nothing but quantitative computation behind strategic, i.e., qualitative decision. Rather, optimal design is the paradigm for supporting designers' decision making. That is, through mathematical formulation of essential and relevant factors and computational generation of solutions, it can provide representative and competitive alternatives and draw out their tradeoff. Since this characteristic is more significant in complicated and complex problems, optimal design methodologies must be effective for rationalizing the practices of strategic product family deployment. In other words, while its overall circumstance shown in Figure 1 is too complicated to be mathematically formulated, the circumstances embedded into four types as shown in Figure 4 become to be able to be tacitly manipulated through computational tradeoff analysis in the cooperation with strategic decision making.

### **5.2 Generality and particularity in mathematical formulation and optimization**

Regarding the contents to be manipulated with optimization computation, Figure 2 gives a general outline on the product family deployment over time frames, Figure 4 transforms it into abstract circumstances for four types of product development, and Figures 5, 6 and 7 demonstrate its concrete circumstances in representative cases. The chain among these models in different standpoints indicates the following points: the design problem of product family deployment can be mathematically formulated as a general form. However, if it is too complicated to be computationally manipulated, it can be abbreviated into particular forms in small scales based on any strategic decision along with the types of circumstances. Therefore, the followings are expected as an example of mathematical development: an entire set of design variables and constrains is generally defined for mathematically representing the contents of Figure 2 and the issues discussed in Subsection 2.2. The circumstance under a particular strategy makes some design variables invariable and makes some constraints irrelevant. Such transformation results in a computable formulation, even the general one is not. Under another viewpoint, any strategic decision must be made up to the level in which the mathematical model becomes moderately computable. Therefore, it must be a research agenda to clarify the appropriate relationship between strategic decision making and computational analysis over the generality and particularity.

Regarding the optimization algorithms, it is obvious that any mathematical formulation on product family deployment is complicatedly combinatorial, because it includes the design variables representing whether a product or module is produced or not, when it is produced, and so forth. While meta-heuristics approaches such as simulated annealing or genetic algorithms are indispensable, their configuration must be based not only on the modes of the optimality, as similar to the case of [3], and but also on the mathematical characteristics of particular problems configured through abbreviation under strategic decisions.

### 5.3 Evaluation criteria on the optimality of product family deployment

Regarding evaluation criteria, i.e., the objective function, the profit through the overall design through production to launch, its robustness, its associated risks, etc. could be the factors of the optimality. While Subsection 2.3 referred some related studies, they focus some aspects included in the product family deployment. Their models may be integrated into the formulation of the objective. At least, regarding the modeling of interaction between product family and the market and management of flexibility, some of them must be good references. Their outcomes, such as discrete choice analysis [7-9], real-options based optimal design [10, 11], flexibility assessment of modules [12], could be systematically integrated onto sophisticated representation of respective types of problems. On the other hand, it becomes a research agenda to consider which one should be integrated and how it should be done so, because their judgment forms the exact contents of the objective function and affects typical modes of underlying tradeoff, computational difficulties, etc.

### 5.4 Necessity and challenges of recurrent planning of product family deployment

The above subsections discussed the application of optimal design to product family deployment as an isolated activity. However, as shown typically in Figure 2, the activities of product family deployment are along with the time frames, and they can be distributed to different time frames. That is, for example in Figure 2, the entire plan of deployment is determined once at the time frame  $t^1$ , but the rest of deployment could be modified at any time frames  $t^2$  to  $t^7$ . If anything, such modification should be ordinarily indispensable when the situation of the market, internal resources, competitors' performance, etc. is changed from the originally assumed one. This issue indicates that recurrent planning of product family deployment over the time frames must be a necessary research agenda beyond ones mentioned in the above. This direction, at least, requires more careful consideration on flexibility of product family deployment, risks embedded in it, tradeoff among them, etc. than one as an isolated activity. Such consideration must include another level of cooperation between strategic decision making and computational analysis.

Besides, while this paper mainly focuses on product family deployment over time frames apart from product platform design, the investigation from the standpoint of the latter and the integration of the former and the latter must be interesting and challenging for further development.

## 6 CONCLUDING REMARKS

This paper discussed the product variety design with focus on strategic planning of product family deployment over time frames, analyzed some cases for validating the general discussion, and extracted some research agendas for developing optimal design methodologies in such directions. While the discussion categorized the problems into four types, the authors plan to develop the optimal design frameworks for respective types and their combinations with various levels of flexibilities one by one toward the enhanced excellence of product variety design. The authors have already investigated into small-scale problems of product family deployment over time frames without any interaction with the market mechanism as a feasibility study toward the direction. It has been confirmed that four typical circumstances shown in Figure 4 are emerged from a general mathematical model through optima design under different parameter setting respectively.

## REFERENCES

- [1] Simpson, T. W., Siddique, Z., Jiao, J. (Eds), *Product Platform and Product Family Design --- Methods and Applications*, 2006 (Springer).
- [2] Fujita, K., Product Variety Optimization under Modular Architecture, *Computer-Aided Design*, 2002, 34(12), 953-965.
- [3] Fujita, K. and Yoshida, H., Product Variety Optimization Simultaneously Designing Module

- Combination and Module Attributes, *Concurrent Engineering --- Research and Applications*, 2004, 12(2), 105-118.
- [4] Ulrich, K. T. and Eppinger, S. D., *Product Design and Development*, (fourth edition), 2008 (McGraw-Hill).
- [5] Ullman, D. G., *The Mechanical Design Process*, (third edition), 2003 (McGraw Hill).
- [6] Hui, L. and Azarm, S., An Approach for Product Line Design Selection under Uncertainty and Competition, *Transactions of the ASME, Journal of Mechanical Design*, 2002, 124, 385-392.
- [7] Wassenaar, H. J. and Chen, W., An Approach to Decision-Based Design with Discrete Choice Analysis for Demand Modeling, *Transactions of the ASME, Journal of Mechanical Design*, 2003, 125, 490-497.
- [8] Michalek, J. J., Ceryan, O. Papalambros, P. Y. and Koren, Y., Balancing Marketing and Manufacturing Objectives in Product Line Design, *Transactions of the ASME, Journal of Mechanical Design*, 2006, 128, 1196-1204.
- [9] Shiau, C.-S. and Michalek, J. J., Optimal Product Design under Price Competition, *Proceedings of the 2008 ASME Design Engineering Technical Conferences and Computers and Information in Engineering Conference*, 2008, Paper No. DETC2008-49176.
- [10] Jiao, J., Lim, C. M. and Kumar, A., Real Option Identification and Valuation for the Financial Analysis of Product Family Design, *Proceeding of IMechE, Part B: Journal of Engineering Manufacture*, 2006, 220, 929-939.
- [11] Gonzalez-Zugasti, J. P., Otto, K. N. and Whitcomb, C. A., Option-Based Multi-Objective Evaluation of Product Platforms, *Naval Engineering Journal*, 2007, 3, 89-106.
- [12] Fujita, K. and Akai, R., Optimal Design of Product Family throughout Commonalization, Customization and Lineup Arrangement, *Proceedings of the 2008 ASME Design Engineering Technical Conferences and Computers and Information in Engineering Conference*, 2008, Paper No. DETC2008-50023.
- [13] Ohtomi, K., *Learning of Design Engineering Based on Elementary Approach*, 2007 (Kogyo Chosakai Publishing).
- [14] Toyota Motor Corporation, <http://toyota.jp/>
- [15] Japan Aerospace Exploration Agency, <http://www.jaxa.jp/>
- [16] Kunkel, P., *Digital Dreams: The Work of the Sony Design Center*, 1999 (Universe Publishing).
- [17] Sanderson, S. and Uzumeri, M., Managing Product Families: The Case of the Sony Walkman, *Research Policy*, 1995, 24, 761-782.
- [18] Kota, S., Sethuraman, K. and Miller, R., A Metric for Evaluating Design Commonality in Product Families, *Transactions of the ASME, Journal of Mechanical Design*, 2000, 122, 403-410.

Contact: Kikuo Fujita  
Osaka University  
Department of Mechanical Engineering  
Graduate School of Engineering  
2-1 Yamadaoka, Suita, Osaka 565-0871, Japan  
Tel: +81-6-6879-7323  
Fax: +81-6-6879-7325  
Email: [fujita@mech.eng.osaka-u.ac.jp](mailto:fujita@mech.eng.osaka-u.ac.jp)  
URL: <http://syd.mech.eng.osaka-u.ac.jp/>

Kikuo Fujita is Professor of Design Engineering in Department of Mechanical Engineering at Osaka University. He teaches and researches in design engineering, product design and systems engineering. He is interested in design methodologies, design optimization, product platform and family design, knowledge management, design process planning, etc.

Ryota Akai is Graduate Student in Department of Mechanical Engineering at Osaka University. He is interested in optimal design methodologies of product platform and family.

Hirofumi Amaya is Graduate Student in Department of Mechanical Engineering at Osaka University. He is interested in design optimization of product platform and family.